

MUR180E, MUR1100E

SWITCHMODE Power Rectifiers

Ultrafast “E” Series with High Reverse Energy Capability

These state-of-the-art devices are designed for use in switching power supplies, inverters and as free wheeling diodes.

Features

- 10 mJoules Avalanche Energy Guaranteed
- Excellent Protection Against Voltage Transients in Switching Inductive Load Circuits
- Ultrafast 75 Nanosecond Recovery Time
- 175°C Operating Junction Temperature
- Low Forward Voltage
- Low Leakage Current
- High Temperature Glass Passivated Junction
- Reverse Voltage to 1000 V
- These are Pb-Free Devices*

Mechanical Characteristics:

- Case: Epoxy, Molded
- Weight: 0.4 Gram (Approximately)
- Finish: All External Surfaces Corrosion Resistant and Terminal Leads are Readily Solderable
- Lead Temperature for Soldering Purposes: 260°C Max. for 10 Seconds
- Shipped in Plastic Bags; 1,000 per Bag
- Available Tape and Reel; 5,000 per Reel, by Adding a “RL” Suffix to the Part Number
- Polarity: Cathode Indicated by Polarity Band

MAXIMUM RATINGS

Rating	Symbol	Value	Unit
Peak Repetitive Reverse Voltage Working Peak Reverse Voltage DC Blocking Voltage	V_{RRM} V_{RWM} V_R	800 1000	V
Average Rectified Forward Current (Note 1) (Square Wave Mounting Method #3 Per Note 3)	$I_{F(AV)}$	1.0 @ $T_A = 95^\circ\text{C}$	A
Non-Repetitive Peak Surge Current (Surge applied at rated load conditions, halfwave, single phase, 60 Hz)	I_{FSM}	35	A
Operating Junction Temperature and Storage Temperature Range	T_J, T_{stg}	-65 to +175	°C

Stresses exceeding Maximum Ratings may damage the device. Maximum Ratings are stress ratings only. Functional operation above the Recommended Operating Conditions is not implied. Extended exposure to stresses above the Recommended Operating Conditions may affect device reliability.

1. Pulse Test: Pulse Width = 300 μs , Duty Cycle $\leq 2.0\%$.

*For additional information on our Pb-Free strategy and soldering details, please download the ON Semiconductor Soldering and Mounting Techniques Reference Manual, SOLDERRM/D.



ON Semiconductor®

<http://onsemi.com>

ULTRAFAST RECTIFIERS 1.0 AMPERES, 800–1000 VOLTS

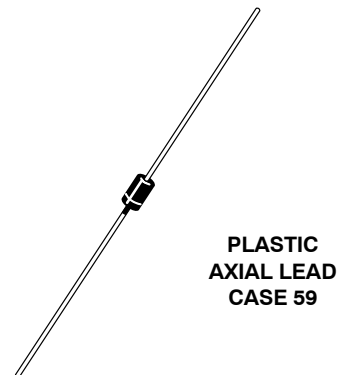

MARKING DIAGRAM

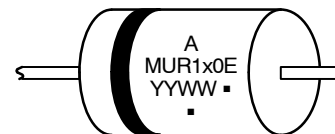

A = Assembly Location
MUR1x0E = Device Code
x 8 or 10
Y = Year
WW = Work Week
▪ = Pb-Free Package
(Note: Microdot may be in either location)

ORDERING INFORMATION

See detailed ordering and shipping information on page 2 of this data sheet.

MUR180E, MUR1100E

THERMAL CHARACTERISTICS

Characteristics	Symbol	Value	Unit
Maximum Thermal Resistance, Junction-to-Ambient	$R_{\theta JA}$	See Note 3	$^{\circ}\text{C}/\text{W}$

ELECTRICAL CHARACTERISTICS

Characteristics	Symbol	Value	Unit
Maximum Instantaneous Forward Voltage (Note 2) ($I_F = 1.0\text{ A}$, $T_J = 150^{\circ}\text{C}$) ($I_F = 1.0\text{ A}$, $T_J = 25^{\circ}\text{C}$)	V_F	1.50 1.75	V
Maximum Instantaneous Reverse Current (Note 2) (Rated dc Voltage, $T_J = 100^{\circ}\text{C}$) (Rated dc Voltage, $T_J = 25^{\circ}\text{C}$)	I_R	600 10	μA
Maximum Reverse Recovery Time ($I_F = 1.0\text{ A}$, $di/dt = 50\text{ Amp}/\mu\text{s}$) ($I_F = 0.5\text{ A}$, $I_R = 1.0\text{ Amp}$, $I_{REC} = 0.25\text{ A}$)	t_{rr}	100 75	ns
Maximum Forward Recovery Time ($I_F = 1.0\text{ A}$, $di/dt = 100\text{ Amp}/\mu\text{s}$, Recovery to 1.0 V)	t_{fr}	75	ns
Controlled Avalanche Energy (See Test Circuit in Figure 6)	W_{AVAIL}	10	mJ
Typical Peak Reverse Recovery Current ($I_F = 1.0\text{ A}$, $di/dt = 50\text{ A}/\mu\text{s}$)	I_{RM}	1.7	A

2. Pulse Test: Pulse Width = 300 μs , Duty Cycle $\leq 2.0\%$.

ORDERING INFORMATION

Device	Package	Shipping [†]
MUR180E	Axial Lead*	1000 Units / Bag
MUR180EG	Axial Lead*	
MUR180ERL	Axial Lead*	5000 / Tape & Reel
MUR180ERLG	Axial Lead*	
MUR1100E	Axial Lead*	1000 Units / Bag
MUR1100EG	Axial Lead*	
MUR1100ERL	Axial Lead*	5000 / Tape & Reel
MUR1100ERLG	Axial Lead*	

[†]For information on tape and reel specifications, including part orientation and tape sizes, please refer to our Tape and Reel Packaging Specifications Brochure, BRD8011/D.

*These packages are inherently Pb-Free.

MUR180E, MUR1100E

ELECTRICAL CHARACTERISTICS

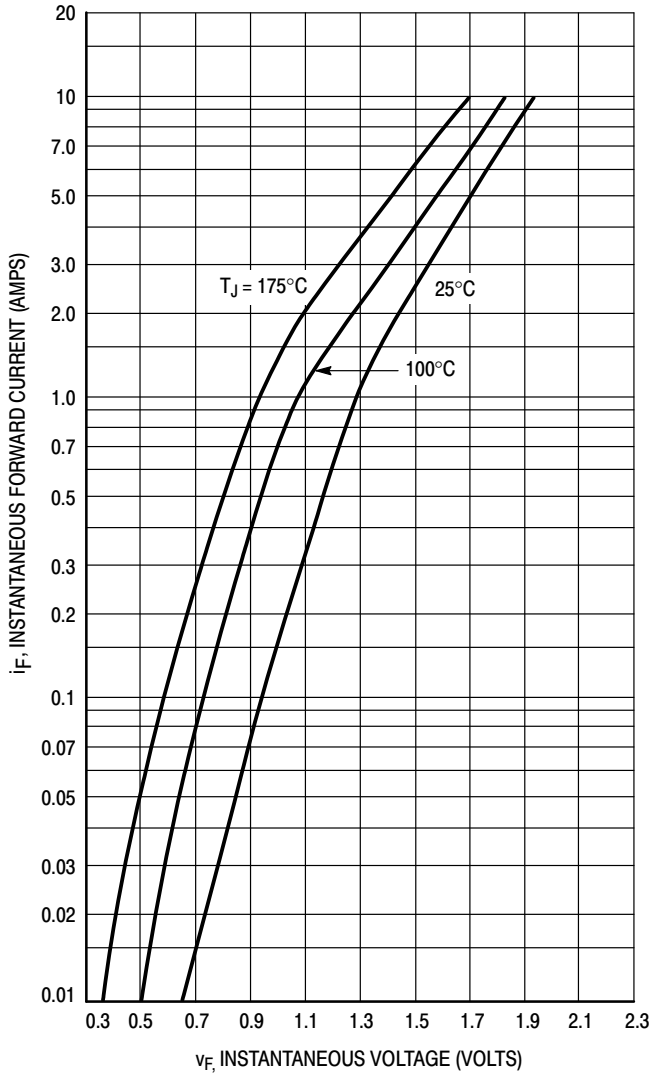

Figure 1. Typical Forward Voltage

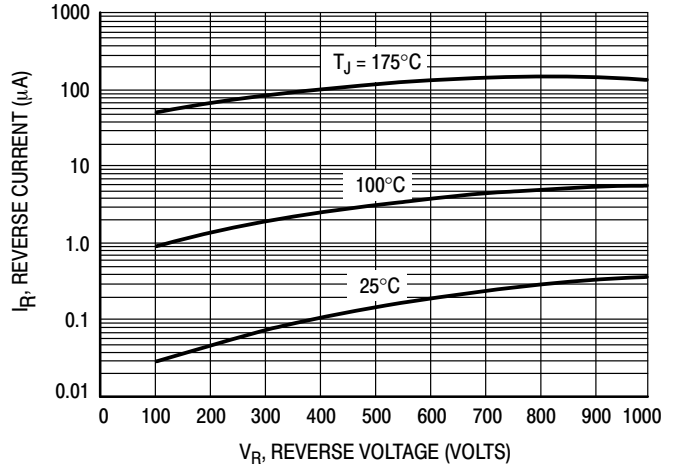
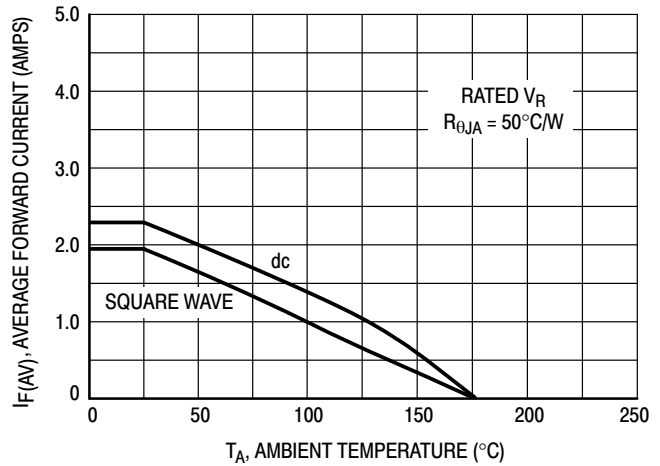

Figure 2. Typical Reverse Current*

* The curves shown are typical for the highest voltage device in the grouping. Typical reverse current for lower voltage selections can be estimated from these same curves if V_R is sufficiently below rated V_R .



**Figure 3. Current Derating
(Mounting Method #3 Per Note 3)**

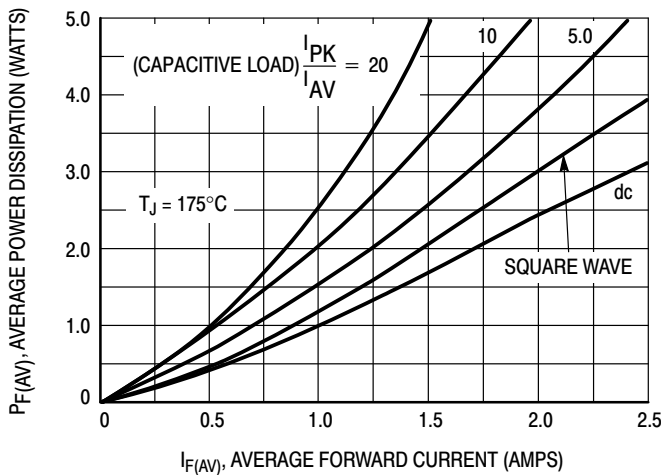

Figure 4. Power Dissipation

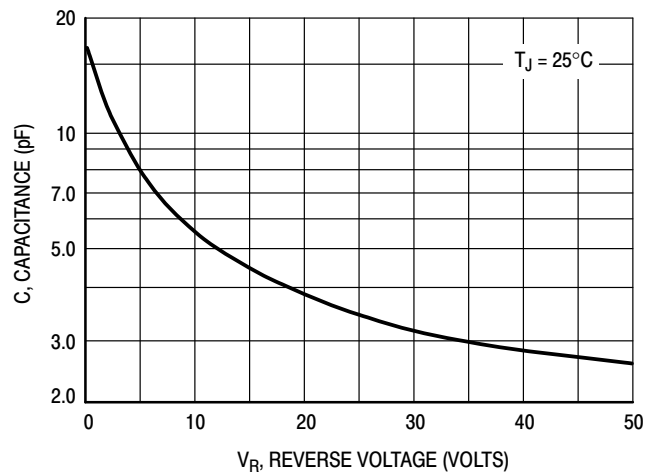

Figure 5. Typical Capacitance

MUR180E, MUR1100E

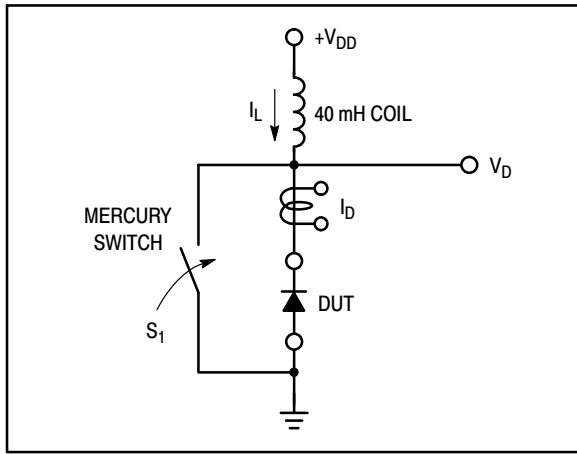

Figure 6. Test Circuit

The unclamped inductive switching circuit shown in Figure 6 was used to demonstrate the controlled avalanche capability of the new “E” series Ultrafast rectifiers. A mercury switch was used instead of an electronic switch to simulate a noisy environment when the switch was being opened.

When S_1 is closed at t_0 the current in the inductor I_L ramps up linearly; and energy is stored in the coil. At t_1 the switch is opened and the voltage across the diode under test begins to rise rapidly, due to di/dt effects, when this induced voltage reaches the breakdown voltage of the diode, it is clamped at BV_{DUT} and the diode begins to conduct the full load current which now starts to decay linearly through the diode, and goes to zero at t_2 .

By solving the loop equation at the point in time when S_1 is opened; and calculating the energy that is transferred to the diode it can be shown that the total energy transferred is equal to the energy stored in the inductor plus a finite amount of energy from the V_{DD} power supply while the diode is in breakdown (from t_1 to t_2) minus any losses due to finite

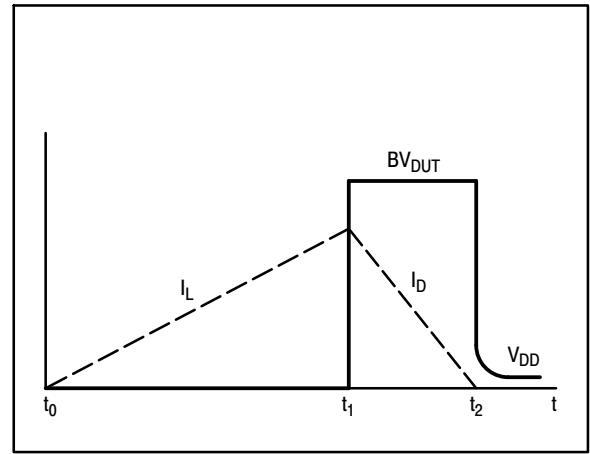

Figure 7. Current-Voltage Waveforms

component resistances. Assuming the component resistive elements are small Equation (1) approximates the total energy transferred to the diode. It can be seen from this equation that if the V_{DD} voltage is low compared to the breakdown voltage of the device, the amount of energy contributed by the supply during breakdown is small and the total energy can be assumed to be nearly equal to the energy stored in the coil during the time when S_1 was closed, Equation (2).

The oscilloscope picture in Figure 8, shows the information obtained for the MUR8100E (similar die construction as the MUR1100E Series) in this test circuit conducting a peak current of one ampere at a breakdown voltage of 1300 V, and using Equation (2) the energy absorbed by the MUR8100E is approximately 20 mjoules.

Although it is not recommended to design for this condition, the new “E” series provides added protection against those unforeseen transient viruses that can produce unexplained random failures in unfriendly environments.

EQUATION (1):

$$W_{AVAL} \approx \frac{1}{2} L I_{LPK}^2 \left(\frac{BV_{DUT}}{BV_{DUT} - V_{DD}} \right)$$

EQUATION (2):

$$W_{AVAL} \approx \frac{1}{2} L I_{LPK}^2$$

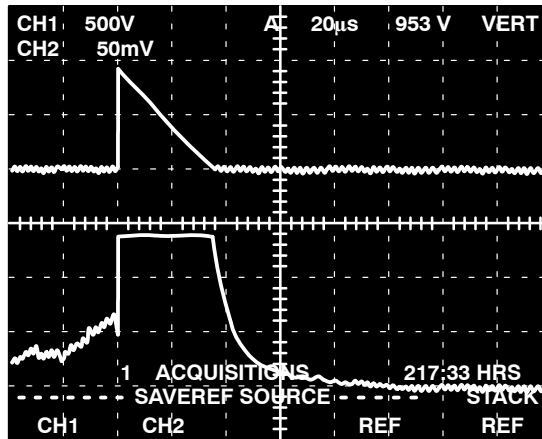

CHANNEL 2:
 I_L
0.5 AMPS/DIV.

CHANNEL 1:
 V_{DUT}
500 VOLTS/DIV.

TIME BASE:
20 μ s/DIV.

Figure 8. Current-Voltage Waveforms

MUR180E, MUR1100E

NOTE 3 – AMBIENT MOUNTING DATA

Data shown for thermal resistance, junction-to-ambient ($R_{\theta JA}$) for the mountings shown is to be used as typical guideline values for preliminary engineering or in case the tie point temperature cannot be measured.

TYPICAL VALUES FOR $R_{\theta JA}$ IN STILL AIR

Mounting Method	Lead Length, L			Units
	1/8	1/4	1/2	
1	52	65	72	°C/W
2	67	80	87	°C/W
3	50			°C/W

MOUNTING METHOD 1

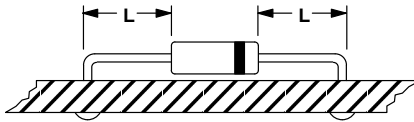

MOUNTING METHOD 2

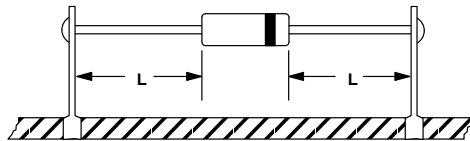

Vector Pin Mounting

MOUNTING METHOD 3

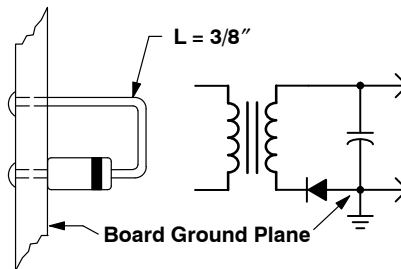

P.C. Board with 1-1/2" X 1-1/2" Copper Surface

MECHANICAL CASE OUTLINE

PACKAGE DIMENSIONS

ON Semiconductor®



AXIAL LEAD CASE 59-10 ISSUE U

DATE 15 FEB 2005



SCALE 1:1

POLARITY INDICATOR
OPTIONAL AS NEEDED
(SEE STYLES)

STYLE 1:
PIN 1. CATHODE (POLARITY BAND)
2. ANODE

STYLE 2:
NO POLARITY

NOTES:

1. DIMENSIONING AND TOLERANCING PER ANSI Y14.5M, 1982.
2. CONTROLLING DIMENSION: INCH.
3. ALL RULES AND NOTES ASSOCIATED WITH JEDEC DO-41 OUTLINE SHALL APPLY
4. POLARITY DENOTED BY CATHODE BAND.
5. LEAD DIAMETER NOT CONTROLLED WITHIN F DIMENSION.

DIM	INCHES		MILLIMETERS	
	MIN	MAX	MIN	MAX
A	0.161	0.205	4.10	5.20
B	0.079	0.106	2.00	2.70
D	0.028	0.034	0.71	0.86
F	---	0.050	---	1.27
K	1.000	---	25.40	---

GENERIC MARKING DIAGRAM*



- xxx = Specific Device Code
- A = Assembly Location
- YY = Year
- WW = Work Week

*This information is generic. Please refer to device data sheet for actual part marking. Pb-Free indicator, "G" or microdot "▪", may or may not be present.

DOCUMENT NUMBER:	98ASB42045B	Electronic versions are uncontrolled except when accessed directly from the Document Repository. Printed versions are uncontrolled except when stamped "CONTROLLED COPY" in red.
DESCRIPTION:	AXIAL LEAD	PAGE 1 OF 1

ON Semiconductor and are trademarks of Semiconductor Components Industries, LLC dba ON Semiconductor or its subsidiaries in the United States and/or other countries. ON Semiconductor reserves the right to make changes without further notice to any products herein. ON Semiconductor makes no warranty, representation or guarantee regarding the suitability of its products for any particular purpose, nor does ON Semiconductor assume any liability arising out of the application or use of any product or circuit, and specifically disclaims any and all liability, including without limitation special, consequential or incidental damages. ON Semiconductor does not convey any license under its patent rights nor the rights of others.

onsemi, **Onsemi**, and other names, marks, and brands are registered and/or common law trademarks of Semiconductor Components Industries, LLC dba "**onsemi**" or its affiliates and/or subsidiaries in the United States and/or other countries. **onsemi** owns the rights to a number of patents, trademarks, copyrights, trade secrets, and other intellectual property. A listing of **onsemi**'s product/patent coverage may be accessed at www.onsemi.com/site/pdf/Patent-Marking.pdf. **onsemi** reserves the right to make changes at any time to any products or information herein, without notice. The information herein is provided "as-is" and **onsemi** makes no warranty, representation or guarantee regarding the accuracy of the information, product features, availability, functionality, or suitability of its products for any particular purpose, nor does **onsemi** assume any liability arising out of the application or use of any product or circuit, and specifically disclaims any and all liability, including without limitation special, consequential or incidental damages. Buyer is responsible for its products and applications using **onsemi** products, including compliance with all laws, regulations and safety requirements or standards, regardless of any support or applications information provided by **onsemi**. "Typical" parameters which may be provided in **onsemi** data sheets and/or specifications can and do vary in different applications and actual performance may vary over time. All operating parameters, including "Typicals" must be validated for each customer application by customer's technical experts. **onsemi** does not convey any license under any of its intellectual property rights nor the rights of others. **onsemi** products are not designed, intended, or authorized for use as a critical component in life support systems or any FDA Class 3 medical devices or medical devices with a same or similar classification in a foreign jurisdiction or any devices intended for implantation in the human body. Should Buyer purchase or use **onsemi** products for any such unintended or unauthorized application, Buyer shall indemnify and hold **onsemi** and its officers, employees, subsidiaries, affiliates, and distributors harmless against all claims, costs, damages, and expenses, and reasonable attorney fees arising out of, directly or indirectly, any claim of personal injury or death associated with such unintended or unauthorized use, even if such claim alleges that **onsemi** was negligent regarding the design or manufacture of the part. **onsemi** is an Equal Opportunity/Affirmative Action Employer. This literature is subject to all applicable copyright laws and is not for resale in any manner.

ADDITIONAL INFORMATION

TECHNICAL PUBLICATIONS:

Technical Library: www.onsemi.com/design/resources/technical-documentation
onsemi Website: www.onsemi.com

ONLINE SUPPORT: www.onsemi.com/support

For additional information, please contact your local Sales Representative at www.onsemi.com/support/sales